



Installation & Owner's Manual

FOR TECHNICAL ASSISTANCE:

CONTACT YOUR LOCAL DISTRIBUTOR

For a list of distributors, visit the Merit Industries, Inc. Web site

www.meritind.com



merit industries, inc.

PM0484-08

Table of Contents

<p>Site Preparation p. 1</p> <p>Setting up your Megatouch Game p. 1</p> <p>Game Description p. 1</p> <p style="padding-left: 20px;">CPU Section p. 1</p> <p style="padding-left: 20px;">Rear Housing p. 1</p> <p>General Care and Maintenance p. 2</p> <p style="padding-left: 20px;">Screen Calibration p. 2</p> <p style="padding-left: 20px;">Monitor Adjustment Procedures p. 2-3</p> <p style="padding-left: 20px;">General Circuit Board Handling Information p. 3</p> <p style="padding-left: 20px;">Cleaning the Cabinet p. 3</p> <p style="padding-left: 20px;">Cleaning the Touchscreen Monitor p. 3</p> <p style="padding-left: 20px;">Cleaning the Fans and Vents p. 3</p> <p style="padding-left: 20px;">Watch Dog Timer p. 3</p> <p style="padding-left: 20px;">Linking Games p. 4</p> <p>Megatouch FORCE Software</p> <p>Game Name and Score Needed for Initial Replay p. 5</p> <p>Main Menu p. 6-7</p> <p>Credits/Pricing Menu p. 8</p> <p style="padding-left: 20px;">Quick Price Setup p. 8</p> <p style="padding-left: 20px;">Coin-In Menu p. 9</p> <p style="padding-left: 20px;">Coinless Coin Op Menu p. 9-10</p> <p style="padding-left: 20px;">Rental Mode p. 11</p>	<p>Games Menu p. 11-12</p> <p style="padding-left: 20px;">Game Setup p. 11-12</p> <p>Hi Scores Menu p. 12</p> <p style="padding-left: 20px;">View/Clear Hi Scores p. 12</p> <p>Books Menu p. 12</p> <p style="padding-left: 20px;">Books Display p. 12-13</p> <p style="padding-left: 20px;">Cash Settlement p. 13-14</p> <p>System Menu p. 15</p> <p>Diagnostics Menu p. 16</p> <p>Presentation Menu p. 17</p> <p style="padding-left: 20px;">Operator's Presentation p. 17</p> <p style="padding-left: 20px;">Sales Person's Presentation p. 17</p> <p style="padding-left: 20px;">Operator Ad Screens p. 18</p> <p>Promotion Menu p. 18-19</p> <p style="padding-left: 20px;">My Merit p. 18-19</p> <p style="padding-left: 20px;">Merit Money p. 19</p> <p style="padding-left: 20px;">Promo Credits p. 19</p> <p>Megatouch FORCE Hardware</p> <p>DIP Switch Settings in FORCE Games p. 20</p> <p>Connecting a Printer (German games only) p. 21</p> <p>Troubleshooting p. 22-24</p> <p>Parts List and Illustrations</p> <p style="padding-left: 20px;">Game Diagrams p. 25</p> <p style="padding-left: 20px;">Replacement Parts List p. 26</p> <p style="padding-left: 20px;">Connection Diagrams p. 27-29</p> <p>Warranty p. 30</p> <p>Software License Agreements p. 31-36</p>
--	---

© 2005 Merit Industries, Inc.

Megatouch Elite Edge, Mega-Link, MegaNet, TouchTunes and TournaMAXX are registered trademarks of Merit Industries, Inc.

Reproduction of this manual, in any form or by any means, is strictly forbidden without the written permission of Merit Industries, Inc.

Site Preparation

In determining the location for your Megatouch FORCE™ video game, consideration must be given to a suitable, grounded electrical outlet. Since the game is a computerized device, it should have a separate circuit, if at all possible. If a separate circuit is not available, care should be taken to provide a clean and constant voltage. As a basic guideline, never connect the unit to a circuit that also supplies power to freezers, coolers or other high power consuming and electrical noise generating equipment. Place the game in a location where nothing will interfere with proper ventilation. The game should not be exposed to any dripping or splashing liquids. Objects filled with liquid should not be placed on the unit.

NOTE: The Elite Edge is not designed to function in an ambient temperature in excess of 95°F or 35°C.

Setting up your Megatouch Game

1. After removing the game from the carton, plug the game into a standard AC outlet.
2. Turn the power switch at the back of the game to ON and wait for it to go through its boot-up sequence. The game will display the Player Menu Screen.
3. The machine has been preset at the factory and therefore should not need to be adjusted, however it is recommended that the screen be calibrated (see **Screen Calibration**) and the coin and/or bill acceptor(s) be tested.
4. There are many custom settings available for the game. To customize the settings, follow the software instructions in this manual.

Game Description

The Megatouch Elite Edge model has 2 key-locked compartments: the CPU section door and the rear door. It comes equipped with a coin mech and/or bill acceptor. There are also couplers installed in the rear of the game for future hardware upgrades including linking and modem capabilities. Some games come with an Ethernet cable and a crossover connector which can be used to link games. For linking information see **Linking Games** in the next section.

CPU Section

The CPU section is accessible from the front of the game. The CPU section houses the LCD monitor, motherboard, I/O board, power supply, hard drive, and the main harness. For bill-only games the centronics connector is also located inside the CPU section (see Figure 24). Also located in the CPU section, near the hinge of the CPU section door, is the control board. Two internal switches (**SETUP** and **CALIBRATE**) are located on the board (see Figure 24). Pressing the **SETUP** button will bring you to the Main Menu Screen (see Figure 1). See the next section for calibration instructions.

Games with Coin Mechs

To gain access to the centronics upgrade connector (to install a software upgrade) and the coin mech, you must open the hinge between the CPU section and rear housing. To do this, unlock and open the CPU section and remove the cotter pin (see Figure 24).

Rear Housing

The rear housing contains the coin box/bill acceptor, the meter and the USB port. The rear door is key-locked for security purposes.

General Care and Maintenance

NOTE: THIS GAME MUST ONLY BE SERVICED BY QUALIFIED SERVICE PERSONNEL.

CAUTION: THERE ARE HIGH VOLTAGE PARTS IN THIS GAME. BE CAREFUL WHEN SERVICING THE INSIDE OF THE GAME. THE GAME SHOULD ALWAYS BE UNPLUGGED BEFORE SERVICING.

Screen Calibration

NOTE: If you are using MegaWeb™ or connecting your game to TouchTunes® product, you must enable high resolution calibration in order to properly view Web pages or activate all of TouchTunes features. All FORCE machines, except for the Classic, can support this high resolution mode. To enable high resolution:

1. Press the **SETUP** button located on the control board inside the CPU section.
2. Touch the **System Menu** button on the first screen that appears.
3. Touch the **Options** button on the System Menu Screen.
4. Scroll through the options until you see **Enable Hi Resolution** and touch the box next to this option so that a check appears in the box.
5. A warning that it should not be enabled on Classic games will appear. If you have a Classic game, touch **No** to exit. If you have any other type of cabinet, touch **Yes** to continue.
6. The game will now have high resolution enabled. Touch the **X** button in the upper corner of the screen to exit out of setup. Then continue with the following screen calibration steps.

How To Calibrate your Touchscreen:

- Find the **CALIBRATE** button on the control board inside the CPU section.
- Touch the center of the first cross that appears on the screen. Once you release your finger, a second cross will appear.

NOTE: You must hold your finger on the circle for approximately 2 seconds for the calibration to be recognized.

- Touch the center of the second cross that appears on the screen.
- Once the second cross is touched and released, another cross will appear on the screen. To test the calibration of the screen, touch the cross with your finger and slowly drag your finger around the screen. The cross should follow your movement.
- Touch the **EXIT** button.

If you have high resolution enabled, the game will prompt you to go through the same steps again for high resolution mode.

Monitor Adjustment Procedure

For adjusting the settings on our monitors, we suggest following the procedures described below. The vertical/horizontal controls and brightness/contrast controls are located on the control board, inside the CPU section near the hinge of the door. Pressing the button labeled **Menu** on the control board will show the on-screen display on the monitor. Use the **Left** and **Right** buttons to move through the menu. Touch **Menu** again to select the option you want to change. Use the **Left** and **Right** buttons to change the option. Then select **Menu** again to deselect the option. **Auto** will automatically adjust the size and brightness. Touch the **Exit** button to exit. Adjust the monitor controls until the screens look as suggested in the following steps.

1. Set the game to the Checkerz game screen.
2. Adjust the vertical and horizontal size and vertical and horizontal position to make sure that the game screen fills the monitor screen and that the game screen is centered.
3. Adjust the brightness and contrast controls until the top sets of checkers are

a rich red and the bottom set are a dark gray. The feet on the **Checkerz** character should be white. (Adjusting the brightness and contrast can also correct for a lack of sharpness.)

General Circuit Board Handling Information

Before handling any boards, observe the following procedures:

- Prevent Electro-Static Discharge by:
 1. Storing the boards in the anti-static bags in which they are shipped.
 2. Removing any static charge from your body before handling the boards.
 3. Using a ground strap when handling the boards.
- When plugging in connectors to the board, make sure the connector is inserted straight onto the header and covers all header pins.
- Do not connect any peripheral device to the board, if the power is still connected to the peripheral or if power is already applied to the board.

CAUTION: Be extremely careful when replacing the lithium battery on the motherboard. There is a danger of explosion if the battery on the motherboard is incorrectly replaced. Only replace the battery with the same type recommended by the manufacturer. Dispose of used batteries according to the manufacturer's instructions.

Cleaning the Cabinet

- The cabinet should be cleaned with a damp cloth and mild detergent. Always apply the cleaner to the cloth and not directly on the game. Liquids could enter the cabinet and damage electronics inside.

Cleaning the Touchscreen Monitor

- The touchscreen glass should be cleaned with a damp cloth and isopropyl alcohol or a *non-ammonia* cleanser. *Do not use any abrasive or vinegar-based cleansers, as they will damage the touchscreen glass.*

NOTE: DO NOT USE ANY ABRASIVE SOLVENTS, ACID OR VINEGAR-BASED CLEANSERS ON THE MONITOR OR SIDE DECALS. OVER TIME, SUCH CLEANSERS COULD HARM THE TOUCHSCREEN AND ERASE THE DECALS. BE CAREFUL NOT TO USE COMMERCIAL CLEANERS CONTAINING ANY OF THESE SUBSTANCES.

Cleaning the Fans and Vents

- The fans and vents should be cleaned of any dust and grime on a regular basis to ensure proper ventilation of the game.
- To ensure proper operation of the game, it is important that all fans are operating correctly and that the airflow is unobstructed. Make sure nothing is placed inside the cabinet or next to the fan vents that would inhibit the flow of air. Also, if any fans are not operating, it is important that they be replaced.

Watchdog Timer

This game has been equipped with a feature that allows it to automatically reboot if it encounters a problem. When the watchdog timer is enabled, it will reboot the machine within 2 minutes after a failure, allowing the game to automatically reset itself if a problem arises without needing a technician present. If you want to disable the watchdog timer, set DIP switch 3 on the I/O board to the open position and reboot the game.

Linking Games

Some games include an Ethernet cable and a crossover connector used to link games together. By linking your games, players can play compete against one another in real-time interactive play. Follow the instructions below to link your games. The software will allow up to 8 games to be linked.

NOTE: One Ethernet cable is required for each game you are linking. Additional Cat-5 UTP RJ45 Ethernet cables can be purchased at your local computer store.

1. Turn off and unplug the games.
2. Connect one end of the supplied Ethernet cable to the Ethernet connector on the outside of the game. The Ethernet connector is the one on the top if you are facing the back of the Elite Edge game (see Figure 25). If the Ethernet cable has a ferrite attached to the end of it, make sure this end is closest to the game.
3. Connect the second Ethernet cable to the Ethernet connector on the outside of the second game.
4. *Linking two games:* Connect the free ends of both the Ethernet cables into the crossover coupler.

Linking more than two games: Connect the free ends of the Ethernet cables into a 10 BASE-T Ethernet hub (available from your distributor as a separate part number (EC0030-01), or at your local computer store).
5. Plug in the games and turn on the power. If installation was successful, you will see a Mega-Link® button displayed on the screen after the menu appears.

NOTE: If you are linking games to a Combo Jukebox or a MegaTunes unit, the free ends of the Ethernet cables from the games will connect directly to the Ethernet ports on the jukebox or MegaTunes unit. If you are linking more than 2 games and a jukebox, or more than 3 games and a MegaTunes, you will need to connect an Ethernet cable to the hub connector on the jukebox or MegaTunes unit and plug the free ends of all of the cables into a hub.

MegaTunes: The Ethernet ports are located on the Ethernet hub mounted to the single board computer (SBC). The 4 ports on the right for Ethernet, the port on the left is for connecting a hub only. Loosen the 2 thumbnuts securing the front access panel. Connect the Ethernet cable to one of the Ethernet ports and replace the front access panel routing the cable through the slots at the bottom of the access panel.

Combo Jukebox: There are two available Ethernet couplers, labeled **Mega-Link**, on the upper left if you are facing the back of the jukebox.

NOTE: The Mega-Link® button will appear on the game only when 2 or more games are linked.

NOTE: If a MegaTunes unit has been linked to a game, the music will be downloaded to the game. This download time will vary depending on the amount of music being downloaded.

NOTE: Megatouch games that are connected using the Mega-Link™ system must have the same level of software for proper operation. The software is designed to detect other levels of software in linked games. If a different level is detected, you will receive a screen that says, "MEGALINK MISMATCH CALL ATTENDANT." This screen will be displayed approximately 5 minutes after you turn the games on. To clear the screen and continue playing the games, you must turn the power off, unlink the games, and turn the power back on again. If you want to link these games you must upgrade all games to the same software level.

Game Name and Score Needed for Initial Replay

Solitaire, Power Solitaire, Lone Star, and Super Lone Star will always offer a replay once the listed score is attained. The other games have to reach the score listed as well as attain the high score for the game in order to offer a replay. **NOTE: The available games may vary.**

11 Ball/11-Up	125,000
3 Blind Mice	150,000
3 Some	150,000
Air Shot	No Replay
Around the World Golf	No Replay
Astro Joe	120,000
Backjammin	125,000
Battle 31	125,000
Big Time Roller	60,000
Boxdrop	175,000
Boxglide	475,000
Boxxi	850,000
Breakin' Bricks	400,000
Card/Castle Bandits	200,000
Card/Crypt Raiders	175,000
Checkerz	28,000
Chip Away	125,000
Chug 21	250,000
Conga Fish (lon only)	No Replay
Conquest	30,000
Crazy Hearts	65,000
Decked Out Uno Poker	100,000
Domino5	200,000
Euchre Nights	5,000
FastTraxx (lon only)	100,000
Fast Lane	100,000
Feeding Frosty	No Replay
Flash 7	125,000
Four Play	1,500,000
F.M.V. Boxxi (lon only)	No Replay
Gender Bender	125,000
Gin Rummy	55,000
GO-O-O-AL	No Replay
Great Solitaire	45,000
H2H Gender Bender	No Replay
H2H Photohunt	No Replay
H2H Safari	No Replay
H2H Trivia	No Replay
Hoop Jones	125
Hooter	No Replay
Jumble	120,000
Jumble Crosswords	120,000
Let It Ride Poker	125,000
Let It Ride Trivia	125,000
Lone Star	45,000
Lookout	400,000
Magic Charms	500,000
Match'Em Up	200,000
Mega Bowling	125
Memoree	300,000
Meteor Shower	200,000
MGA Champ. Golf	No Replay

Mini Golf/Crazy Golf	No Replay
Monkey Bash	No Replay
Monster Madness	400,000
Moon Drop	160,000
Mystery Phrase	325,000
Outer Spades	75,000
Pharaoh's Fortune	45,000
Pharaoh's 9	No Replay
Photo Hunt	400,000
Pile High	No Replay
Pix Mix	350,000
Power Solitaire	55,000
Power Trivia	No Replay
Puck Shot	3,000
QB Zone	65,000
Q-Shot	50,000
Quik Cell	100,000
Quik Chess	125,000
Quik Match	400,000
Quintzee	60,000
Quiz Show	45,000
Race Poker/Motor Match	No Replay
Rack 'Em	200,000
Rack 'Em 9 Ball	35,000
Royal Flash	300,000
Run 21	250,000
Snapshot	400,000
Space Crusader (lon only)	No Replay
Space Adventure Golf	No Replay
Speed Draw	125,000
Sticker Book	No Replay
Strip Club	No Replay
Super Lone Star	55,000
Super Snubbel	No Replay
Tai Play	240,000
Take 2	110,000
Tennis Ace	No Replay
Texas Hold 'Em	No Replay
Tic Tac Trivia	75,000
Tri-Castles	125,000
Trip Flip	150,000
Tri-Towers	125,000
Trivia Treasure	No Replay
Trivia Whiz	No Replay
TV Guide Mini Crossword	50,000
Video Whiz (lon only)	No Replay
Vinci-Ball	400,000
Wild 8's/Wild Apes	400,000
Word Dojo	375,000
Word Fever	155,000
Word Safari	125,000
Wordserve	200,000
Wordster	100,000
Zip 21	200,000

Main Menu

The Main Menu can be accessed by pressing the SETUP button inside the game. Use the Main Menu to set up all game software options.

NOTE: For help with the Options in any menu section, touch the green “?” buttons to bring up a help screen.

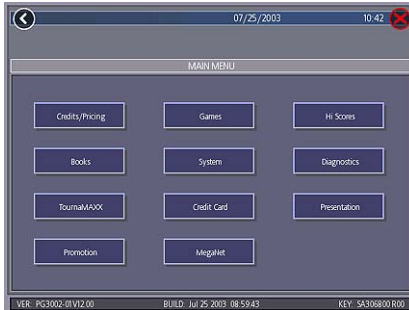

FIGURE 1 - MAIN MENU

A summary of the Main Menu functions appears in the following table. For more detail, see the corresponding sections of the manual.

Main Menu	Available Options	Information
CREDITS/ PRICING	<ul style="list-style-type: none"> • Quick Price Setup • Coin-In • Value of a Credit • Coinless Coin Op • Pay Per Time • Options • Clear Credits • Free Credits 	The Credits Screens allow the operator to set credit rules for all games, set up the Coin-In Menu, enable the Coinless Coin Op feature, enable the Rental Mode feature, select freeplay mode, and add or clear credits.
GAMES	<ul style="list-style-type: none"> • Game Setup • Options 	In the Games Screens, you can edit the game list (choose which games are available and in what category they appear on the Category Menu), and select options for individual games.
HI SCORES	<ul style="list-style-type: none"> • View/Clear Hi Scores • Options 	Touch CLEAR ALL GAMES to clear all high scores or select a particular game to edit high scores for that game.
BOOKS	<ul style="list-style-type: none"> • Books Display • Cash Settlement Setup • Cash Settlement Collection 	The Books Screens display current and lifetime credits information as well as calculate and collect the location and operator fees.
SYSTEM	<ul style="list-style-type: none"> • Set Time • Security Setup • Set Game Serial Number • Volume Control • Set 6 Star PIN • Data Transfer • Options 	Set the game clock, security PIN, serial number, game volume, 6 star PIN and features, and system options such as language control, 6 Star Enable, and theft deterrent. Also use this menu to transfer books data with a USB Pen.

Main Menu	Available Options	Information
DIAGNOSTICS	<ul style="list-style-type: none"> • Video Test • I/O Test • Touchscreen Calibration • Touchscreen Test • View System Log • Checksum Test • System Info 	<ul style="list-style-type: none"> • Enters the Video Test to display the test screens. Touch the screen to cycle through test. • Tests the function of the I/O board, DIP switches, coin meter, lockout (if applicable), and light (EVO only). • Allows the operator to calibrate the touchscreen. Follow the instructions on the screen. • Checks touchscreen calibration. Touch the crosshairs on the screen to make sure it is accurately following your movement. • Displays operations performed by the game. • Checks the hard drive for missing or corrupted files. • Gives details about various hardware components in the game.
TOURNAMAXX	<ul style="list-style-type: none"> • Internet Connection • General Info • Connection Log • Set Update Time • Update From Server • Clear Database 	<p>Also enters the TournaMAXX / TournaCHAMP Set-Up Screen if the game is registered for Tournament play. For more information, see the MegaNet® installation manual.</p>
CREDIT CARD	<ul style="list-style-type: none"> • Credit Card Setup • Dial-In Setup • Credit Card Test 	<p>Enters the Credit Card Set-Up Screen if a credit card swipe is installed in your game. For more information, see the Credit Card Kit Installation Instructions.</p>
PRESENTATION	<ul style="list-style-type: none"> • Operator's Presentation • Sales Person's Presentation • Operator Ad Screens 	<p>Displays a slide show designed to be presented to location owners by the operator and another slide show to be presented to operators and distributors by the sales person. Also allows the operator to create ad screens and add custom screens created on a personal computer.</p>
PROMOTION	<ul style="list-style-type: none"> • My Merit • Merit Money • Promo Credits • Options 	<ul style="list-style-type: none"> • Enables a feature permitting players to create custom accounts. Also displays individual player data and allows the operator to back up or restore My Merit data. • Sets time periods in which location owners can use the 6 Stars feature to offer free credits to encourage game play. • Sets time periods in which the game offers a free credit while in Idle Mode. • Enables My Merit, Merit Money, and Promo Credits features.
MEGANET	<ul style="list-style-type: none"> • Entertainment Channel • Premium Erotic • Prize Zone • MegaWeb • Operator Web Access • Hot Topics • Options 	<p>Enters the MegaNet Set-Up Screen if the game is registered for TournaMAXX/TournaCHAMP play. Features must be enabled for the corresponding button to appear. For more information, see the MegaNet/ TournaMAXX installation manual.</p>

Credits/Pricing Menu

Quick Price Setup - *This feature is only available in U.S. games.*

Quick Price Setup allows the operator to make general pricing changes without entering the Games Menu.

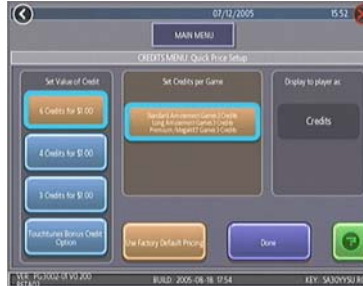

FIGURE 2 - QUICK PRICE SETUP SCREEN

6 Credits for a Dollar (default setting): Sets each game to the following price settings:

NOTE: The Coin-In Table cannot be adjusted with **6 Credits for a Dollar** selected.

COIN INPUT	COIN VALUE	COINS	=	CREDITS	&	METER PULSES
1A	25¢	1		1		1
2B	25¢	2		2		2
3C	25¢	3		4		3
4D	25¢	4		6		4

NOTE: If the game is set to 3 or 6 Credits for a Dollar, prices will display as Credits.

4 Credits for a Dollar: Sets each game to the following price settings:

COIN INPUT	COIN VALUE	COINS	=	CREDITS	&	METER PULSES
1A	25¢	1		1		1
2B	25¢	1		1		1
3C	25¢	1		1		1
4D	25¢	1		1		1

3 Credits for a Dollar: Sets each game to the following price settings:

COIN INPUT	COIN VALUE	COINS	=	CREDITS	&	METER PULSES
1A	25¢	1		1		2
2B	25¢	3		2		3
3C	25¢	4		3		4

TouchTunes Bonus Credit Option: Sets jukebox credits to the following settings on the Megatouch Combo Jukebox or MegaTunes unit. To see the TouchTunes credit settings, enter the Coin-In Menu after touching the TouchTunes Bonus Credit button. If you are linking the game to a TouchTunes unit, you should select this option for correct jukebox pricing.

COIN INPUT	COIN VALUE	COINS	=	CREDITS	&	METER PULSES
1A	25¢	2		1		2
2B	25¢	3		2		3
3C	25¢	4		3		4
4D	25¢	8		10		8
5E	25¢	20		26		20

The operator can also use this screen to determine whether prices are displayed to players as credits or monetary amounts, and set the cost of Standard Amusement, Long Amusement, and Premium/MegaNETgames. Touch the **Use Factory Default** button to restore default values.

Coin-In Menu



FIGURE 3 - COIN-IN MENU

Game cost can be controlled two ways: by changing the number of credits required to play a game or by changing the cost of a credit. The Coin-In Menu allows you to adjust the cost of a credit, as well as provide a way to give players “bonus” credits for depositing a higher amount of money. Use the left and right arrows to change the number of credits.

When programming the Coin-In Menu, Channel 1 is set for the lowest value coin, Channel 2 for the next highest value, etc. Meter pulses are independent of credits and only track the unit of currency. Players are given an incentive to deposit more money by giving them “bonus” credits for depositing larger denominations. Coins may be deposited in any combination of values and the game will automatically register the highest number of credits for the total amount of coins deposited. Once a game is played, any remaining fractional credits are erased.

Generally, most countries have a factory default setting. This setting can be adjusted (as described above), but will return if the game memory is cleared. Some programs, depending on the key used, have a currency default display located to the left of the coin inputs. It shows the currency value for each of the coin inputs. This display is used as a guide and is not used in any calculations.

Touch the currency default display to hide/show the display.

To give customers bonus credits for inserting a five-dollar bill, the \$5 line must be enabled in the Coin-In Menu. To enable it, enter the Quick Price Setup Screen and select **6 Credits for \$1.00, 4 Credits for \$1, 3 Credits for \$1.00 or Use Factory Default Pricing**. **NOTE:** You must touch one of the available options on the Quick Price Setup Screen to enable the \$5.00 row. Then, enter the Coin-In Menu and adjust the number of credits in the \$5.00 row.

Coinless Coin Op Menu

When enabled via the Options button on the Credits/Pricing Menu, the Coinless Coin Op feature allows the operator to charge on a per-game or per-time basis without players inserting money into the game. The total amount owed after gameplay is tallied by the machine and collected by the location owner. Location owners reset the game with a PIN after collection.

NOTE: If you have set a tax fee on the Cash Settlement Screens, Coinless Coin Op Mode play will be taxed at the set rate. If you want to set the tax percentage at a different rate for Coinless Coin Op mode and regular mode, you should perform a Cash Settlement Collection before switching modes.



FIGURE 4 - PLAYER MENU IN COINLESS COIN OP (TIME AND PER GAME MODES BOTH ENABLED)

Certain features will not be available in Coinless Coin Op Mode, such as MegaNet content, Merit Money, Promo Credits, Free Credits, TouchTunes® music. Pricing for these features can only be displayed in currency values, not credits.

Settings

Touching the Settings button allows the operator to choose whether players can play Per Game, Per Time, or both when the game is in Coinless Coin Op mode. Per Time pricing can be changed on this screen with the up and down arrows. The currency amount will apply to each 15-minute time block selected by the customer.

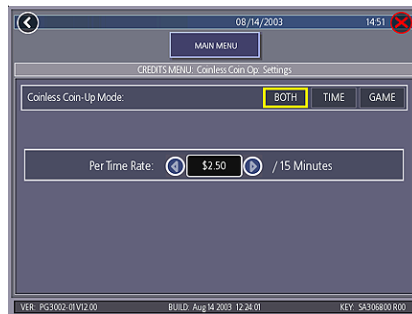

FIGURE 5 - COINLESS COIN OP MENU - SETTINGS SCREEN

Setting the PIN

Touch the Set PIN button on the Coinless Coin Op Menu to program the PIN. The number can be from 1 to 5 digits.

NOTE: The Coinless Coin Op PIN can also be set from the Player Menu. Touch the Options button, enter the 6 Star PIN, and touch the CCO Set PIN button.

Disabling the Money Inputs

It is recommended that the money inputs be disabled when the game is in Coinless Coin Op mode. Unplug the power and signal harness connected to the bill/note acceptor and the harness connected to the coin mech (if applicable) to disable the inputs.

Per-Game Mode

When players choose this mode, a running total of the amount owed is maintained and displayed in the CREDITS box on the screen. The total is tabulated after each game or function. The location owner then collects the total amount owed at the end of gameplay. If there is no activity for 10 minutes, the machine will disable and the amount owed by the player will display on screen. No further gameplay can occur until the machine is reset by a location employee using the PIN.

Time Mode

The price per 15-minute time block will be displayed before players choose this mode. During gameplay, the time remaining and amount owed by the player will be displayed on screen. When the time block runs out, players can purchase additional time. Otherwise, the machine will disable and the amount owed by the player will display on screen. No further gameplay can occur until the machine is reset using the PIN. If the player leaves the game before the purchased time block has ended, the game can be reset using the PIN.

Resetting or Freezing the Game

The game can be reset at any time using the pre-programmed PIN. Once gameplay totals have been tallied by the machine, the attendant can also choose to freeze the game to prevent more activity until the transaction is complete. The Reset or Freeze buttons are accessible through the Options button on the Player Menu after touching the Coinless Coin Op button. An alarm will begin to sound after 3 failed attempts to enter the valid number when entering the PIN to reset the game. The alarm will terminate when the machine is rebooted, the operator SETUP button is pressed, or the correct PIN is entered.

Rental Mode

When enabled via the Options button on the Credits/Pricing Menu, Rental Mode allows players to purchase a block of time and use it to play as many games as they want.

To set the value of a credit in Rental Mode, select **Pay Per Time** from the Credits Menu. Touch the arrows on either side of the time interval to adjust the number of minutes of play given for each credit. To disable any row, set the minute value to zero.

To Enter This Screen, Touch “Pay Per Time” on the Credits Menu



FIGURE 6 - PAY PER TIME SCREEN

Certain features will not be available in Rental Mode, such as MegaNet, Merit Money, Promo Credits and Free Credits. Rental mode is also unavailable with linked games.

NOTE: It is recommended that you clear the books when toggling Rental Mode on and off in order to ensure accurate bookkeeping.

Games Menu

Game Setup

The game list and prices, as well as game options, are programmed using these screens. The first screen shows the various game categories and allows access to the following general settings for all games.

To Enter This Screen, Touch “Game Setup” on the Games Menu and Select a Category



FIGURE 7 - GAMES MENU: GAME SETUP

Enable All Games Into Menu: Turns on all games (certain games which were previously displayed in the Game Setup have been turned off in this software) and defaults the price settings.

Factory Default Games Into Menu: Returns the Game Setup to its default settings. Games that were not originally enabled will be turned off and all price settings will be reset.

When you touch a category name, the next Game Setup Screen shows the game positions available for that category and the price for each game, with the list at the bottom showing all games available for the selected category. In categories with Merit-thon games, players who choose Merit-thon play one round of three different games in that category for one combined score.

The Game Setup Screen also allows you to make these general changes:

Default Games: Resets the selected category menu to its default game and price settings.

Clear One: Clears a selected item from the player's game menu.

Clear All: Clears all games from the player's game menu.

Enable All Games: Turns on all games within the selected category and defaults the price settings.

To customize a particular game list, first select a category on the first Game Setup Screen. On the second screen, touch **Clear All** to clear the game list. Choose the menu position you want a particular game to occupy by touching that position, then touch the desired game name from the game list on the bottom of the screen. Repeat until all desired games appear in the menu (a game cannot appear in the list more than once). Games already in the menu will be red in the game list at the bottom of the screen.

To adjust the price, touch the credit or currency value next to each game.

Some games support a continue function. In the cost to continue column, games without this function will display N/A. Games that support continuation will show a credit value. The cost to continue is adjustable on a game by game basis. Touch the credit value button to change the amount. Hit **NEXT** to return to the Games Category page.

NOTE: The default Cost to Continue price is the same as the default cost to play the game; however, the Cost to Continue does not need to be the same amount as the original price.

Hi Scores Menu

View/Clear Hi Scores

Use this menu to manage hi scores. The first screen allows you to clear all scores for all games by touching **Clear All Games**. To edit the hi scores for an individual game, select that game on the first screen.

To Enter This Screen, Touch “View/Clear Hi Scores” on the Hi Scores Menu and Choose a Game

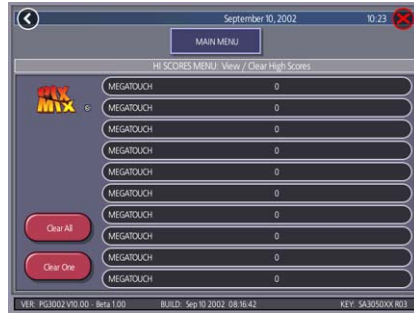

FIGURE 8 - HI SCORES MENU:
VIEW/CLEAR HI SCORES SCREEN

Touch **Clear All** to remove all hi scores for that particular game or select an individual score and touch **Clear One** to remove that particular score only.

Books Menu

The Books Screens display the current and lifetime credit totals for each game, as well as the percentage of credits played per game (the percentage for each game is the total number of credits played on that game divided by the total number of credits entered into the machine).

Books Display

To Enter This Screen, Touch “Books Display” on the Books Menu



FIGURE 9 - BOOKS MENU:
BOOKS DISPLAY SCREEN

The books information can be sorted in three ways with the button that toggles through the sorting categories. **Unsorted** displays the books information in the standard order. **Sorted by Current** displays the current credits for each game from most to least played. **Sorted by Lifetime** displays the lifetime credits for each game beginning with the most played game.

Touch **TournaMAXX Statistics** or **Tournament Statistics** to get the books information for that play only. Touch **Clear Current** to erase all current books data. The date the data was last cleared will appear at the top right of the Books Screen.

Touch the **+** above Total Credits to view Current and Lifetime credits for each game mode. Touch the button again to minimize this screen.

To Enter This Screen, Touch “Books Display” on the Books Menu and Choose a Game Name



FIGURE 10 - BOOKS MENU: BOOKS DISPLAY SCREEN WITH GAME SELECTED

Touching a game name will display the current and lifetime credit totals*, broken into 1-4 player, linked game, and Megatouch Nation plays (Ion only). It also shows the shortest, average, and longest playing times for that game.

***Touching Trivia or Power Trivia displays totals by category.**

Books Display also shows coin input data, as well as Promotional Credits, Merit Money, and Coinless Coin Op totals (when these features are enabled). Touch the **+** above Total Coins to display individual coin input statistics and MegaNet® Credits to display the totals for each MegaNet® category. Touch the button again to minimize this screen.

NOTE: Books data can be exported to a file USB pen via the System Menu/Data Transfer/Export Books feature. The .data file can then be viewed with a word processing program after connecting the storage device to a personal computer. The file will display basic game information such as the software version, the game serial number, and date/time information relating to books data. The file will also show the current and lifetime credit totals, as well as credit totals for each game featured on the machine.

Cash Settlement Setup

The Cash Settlement Screens are used to calculate the percentage of earnings the operator and location will receive, as well as any fees collected by the operator. This will help to offset MegaNet operation costs.

To Enter This Screen, Touch “Cash Settlement Setup” on the Books Menu and touch “NEXT”

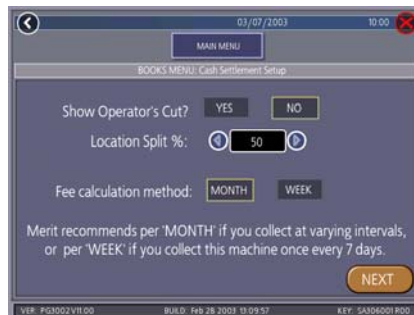

FIGURE 11 - BOOKS MENU: CASH SETTLEMENT SETUP SCREEN

The first screens allow you to set up the Cash Settlement Screen. Choose YES or NO to display the operator's cut on the Cash Settlement Collection Screen and enter the percentage of revenue the location will receive. Also, select the fee calculation method. Select per month if you do not make regular weekly collections or per week if you collect every 7 days. Then touch NEXT.

NOTE: Monthly fee collections are based on 4.3 week month. If you change your fee calculation method, the game will auto adjust the fees by multiplying or dividing by 4.3 and rounding to the nearest penny.

NOTE: Make sure the time and date are set on the game in order to ensure correct fee calculation.

The next screen allows you to set up the fees. The amounts can be changed on screen by touching the amount itself and using the keypad to enter a dollar figure. The other two columns display the cumulative totals for each fee and the totals for the current collection period. Fees are calculated on a prorated, per-day basis. Touch the NEXT button to display more groups of fees. After setting up the fees, touch FINISH to save your changes.

To Enter This Screen, Touch “Cash Settlement Setup” on the Books Menu and touch “NEXT” Twice



FIGURE 12 - BOOKS MENU: CASH SETTLEMENT SETUP SCREEN

To Enter This Screen, Touch “Cash Settlement Collection” on the Books Menu

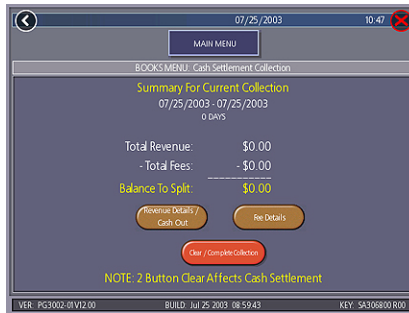

FIGURE 13 - BOOKS MENU: CASH SETTLEMENT COLLECTION

Cash Settlement Collection

The Cash Settlement Collection Screens will display the balance (total revenue minus total fees) to be split between the operator and the location.

Touch **Revenue Details/Cash Out** or **Fee Details** for breakdowns and **Clear/Complete Collection** to finish. Cash Settlement totals will reset once collection is complete.

System Menu



FIGURE 14 - SYSTEM MENU

Set Time	The Set Time Menu allows you to set both the time and date on the game. Time is shown in 24-hour, "military" time (e.g. 5:00pm = 17:00). Use the up and down arrows to set the time and date.
Security Setup	The operator can set the PIN number and select which of the features (Coin-In Menu, Free Credits, Game Menu, Hi Scores, Books, All Options, and Set 6 Star PIN) will be protected by the PIN. To change the PIN, you must first enter the existing PIN (the default PIN is 0000), then enter a new 4-digit number and touch SET on the keypad. The game will prompt you to re-enter your PIN to confirm. After confirming your PIN, touch the button for each of the features you wish to protect with the PIN.
Set Game Serial Number	Use this screen to enter the game's serial number using the keypad.
Volume Control	Touch the volume control button to adjust the volume up or down. This screen allows you to sample the sound volume without exiting the screen. The on-screen volume control can also be accessed using 6 Stars.
Set 6 Star PIN (only appears if PIN is enabled)	Brings up the Set 6 Star PIN Screen via the Options button on the Player Menu. Set the 6 Star PIN (between one and six digits) using this screen. You can enable this feature and choose which options will be accessible by 6 Stars using the System Menu: Options Screen. Touch an option box under System Menu: Options for on-screen help.
Data Transfer	Transfer information (Books data, My Merit data and ad screens) using a USB Pen.
Setup Operator Keys (ION only)	Use this screen to program or erase Operator keys to enable or disable access to the setup screens by using the key.
Options	For help with the Options in any menu section, touch the option box to bring up a help screen.

Diagnostics Menu



FIGURE 15- DIAGNOSTICS MENU

Video Test	Touch the screen to cycle through a series of video test screens.
I/O Test	Tests the SETUP and CALIBRATE buttons, all coin channels, the coin meter, and the coin lockout feature (if applicable). A green light next to the appropriate button will register each time that item is tested, and the number next to the item should increment by one with each test. The screen also displays which DIP switches are on or off.
Touchscreen Calibration	Follow the on-screen instructions to calibrate the touchscreen.
Touchscreen Test	Allows you to check the touchscreen calibration accuracy. The crosshairs should follow your finger exactly when you move it across the screen.
View System Log	Displays a log of all operations performed by the game since the log was last cleared. This information is helpful for customer service in troubleshooting your game.
Checksum Test	Checks the hard drive for missing or corrupted files. With STOP ON ERROR? set to YES, a message indicating which file is corrupted will be shown whenever the game encounters an error. With STOP ON ERROR? set to NO, a list of corrupted files will be displayed when the test is complete. If errors are detected, the software on the drive may need to be reloaded. If this does not solve the problem, the drive may require replacement. The test could take up to 30 minutes.
System Info	Gives details about the following: <ul style="list-style-type: none"> • processor type and speed • motherboard manufacturer • amount of memory • Ethernet card manufacturer • sound chip type • video chip type • touchscreen manufacturer • hard drive manufacturer and capacity • modem part identification number • fan speed • status
Verifying Databases	Only use on the advice of Merit Technical Service. An Update from Server must be performed prior to verifying databases.
Joystick Calibration (ION only)	Follow the on-screen instructions to calibrate the joystick.
Joystick Test (ION only)	Allows you to check the joystick calibration accuracy. The crosshairs should follow the movement of the joystick.

Presentation Menu

The Presentation Menu features a slide show for location owners and another slide show for operators and distributors. This menu also allows operators to create ad screens and add custom screens created on a personal computer.

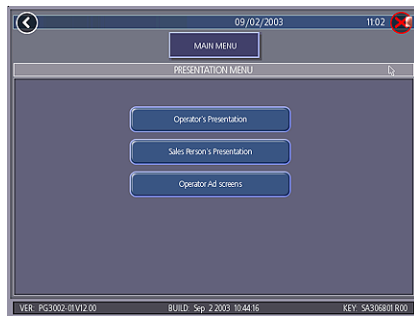

FIGURE 16 - PRESENTATION MENU

Operator's Presentation

This presentation is designed to be shown to location owners by the operator. It demonstrates how to maximize earning potential with the game and increase profit with additional products.



FIGURE 17 - OPERATOR'S PRESENTATION SAMPLE SCREEN

Sales Person's Presentation

This presentation is designed to be shown to operators and distributors by the sales person. In addition to illustrating the revenue potential of the games, it gives details on available products and game content.



FIGURE 18 - SALES PERSON'S PRESENTATION SAMPLE SCREEN

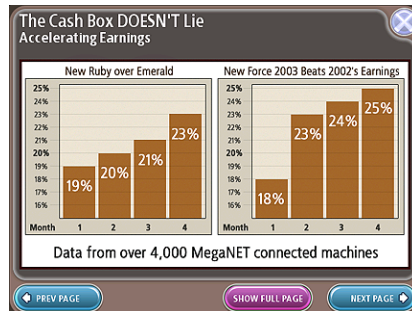

FIGURE 19 - SALES PERSON'S PRESENTATION SAMPLE SCREEN

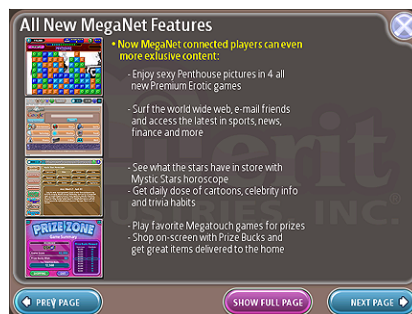

FIGURE 20 - SALES PERSON'S PRESENTATION SAMPLE SCREEN

Operator Ad Screens

A total of 24 advertising screens can be created with the software and added to the game. The ads will appear along with the other attract screens when the game is in idle mode. Custom images for ad screens can also be added to the game using an appropriate storage device for your game (USB pen or CD). Touch the green ? buttons on each screen for information on how to create ad screens and add custom screens to the machine.

In addition, a program for adding up to 120 additional ad screens can be downloaded from our Web site (www.meritind.com) in the Support/Software Downloads section.

FORCE and ION games only: A USB Pen Kit (kit number KAV-100-008-01) is available. To order, contact your local distributor.

Promotion Menu

The Promotion Menu is designed to encourage player interest. Use the Options button to enable each feature.



FIGURE 21 - PROMOTION MENU

My Merit

The My Merit feature allows individual players to create custom accounts, accessible via PIN numbers. Accounts can be created by touching the **My Merit** button on the Player Menu or by accepting the option to create an account after achieving a Hi Score.



FIGURE 22 - MY MERIT OPTIONS

Players will then have the choice to log in to their accounts through the My Merit button on the Player Menu and have personal data stored on the machine. Players can view their hi scores and the number of games they've played in the My Merit mode for the last year.

NOTE: My Merit data will be cleared when a software update is performed. Be sure to back up the data before updating the game. Conversely, backing up data onto the USB pen will also overwrite any existing My Merit data on the USB pen.

View Player Data

Touch **View Player Data** after selecting **My Merit** from the Promotion Menu to bring up a list of all players with My Merit accounts. Touching a player's name will bring up the PIN, total number of games played, and date the account was created. The **Show Hi Scores** button will display a list of the games on which the player has the hi score and the score itself. The operator can also reward the player with free credits on the View Player Data screen.

Show Game Play Frequency

This feature shows the number of games played by each My Merit player. The operator can choose whether to display all totals or just those that fall within a certain date range.

Show Player Hi Scores

Selecting a game name under this feature will bring up the Hi Scores of each My Merit player for that game, as well as the date the score was achieved. The operator can choose whether to display all Hi Scores or just those that fall within a certain date range.

Backup/Restore

My Merit data can be backed up or restored with a USB pen. After connecting a pen to the machine, touch this button to proceed with backing up or restoring all My Merit data. USB pen kits (kit number KAV-100-008-01) are available. To order, contact your local distributor.

NOTE: Restoring My Merit data from a storage device will erase any My Merit data currently on the game.

Merit Money

The Merit Money screens allow location owners to encourage game play by offering free games (not free credits) at certain time intervals via the 6 Star feature. Select days of the week, time frames, and the number of free games (1-10 per day) to be awarded, as well as a PIN number for location owners to use in order to access Merit Money using the 6 Stars feature. Location owners can enable Merit Money by entering that specific PIN in the 6 Stars screen. One free game is given away each time the location enters the code until the predetermined daily limit is reached. Free games expire after 10 minutes, when money is deposited into the machine, or when the Merit Money time period comes to an end.

Promo Credits

The Promo Credits feature generates interest by offering operator-controlled free credits while the game is in idle mode. Select days of the week, time frames, idle time (number of minutes the game would be in idle mode before free credits are offered) and the number of credits (1-10) to be awarded. A message announcing that free credits are available will appear on the screen during idle mode when Promo Credits go into effect. Promo Credits expire after 10 minutes or when the Promo Credits time period comes to an end.

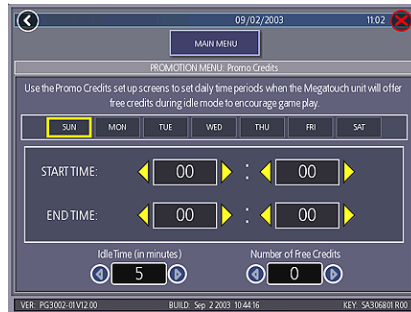

FIGURE 23 - PROMO CREDITS SCREEN

DIP SWITCH SETTINGS

The following table provides information on the functionality of the hard DIP switches in Megatouch games. Make sure to read the information in the **Notes** column to determine what is affected when performing these functions. After performing any DIP switch function, make sure to follow the instructions on the screen. In most cases, you will be instructed to reset the DIP switch in order to reboot the game. If you fail to reset the DIP switch before rebooting, it could result in corruption of the hard drive.

NOTE: The DIP switch functionality is also built into the software. To access the DIP switches through the software:

Turn off the game. Set DIP switch 1 to the closed position. Turn power on. When the message "Please reset DIP 1 to proceed" appears, reset DIP 1 to the open position. The Merit diagnostics page will appear. Touch ? for information on DIP switch functionality. Touch the specific DIP switch to activate it. Touch X to exit.

DIP#	Function	Usage/Notes
8	Motherboard configuration & checksum test	<ul style="list-style-type: none"> Configures the CMOS settings on the motherboard to Merit specifications and checks the files on the hard drive. <p>A checksum test should be performed when the game is locking up or rebooting. If the test fails, the program should be reloaded onto the hard drive. After reloading, perform another checksum test. If it fails again, the hard drive should be replaced.</p>
6	Hardware configuration	<ul style="list-style-type: none"> Identifies system hardware and configures the motherboard. <p>A hardware configuration occasionally needs to be performed after a kit is installed and the touchscreen is not responding to touch or the calibration is off.</p>
5 & 7	Memory clear for Tournamaxx™ and TouchTunes®	<ul style="list-style-type: none"> Clears the login name, password, access phone number, and all call-in settings for Tournamaxx users. Clears all the loaded albums for TouchTunes users. Clears current books, coin-in, high scores and resets the software options. <p>A memory clear should be performed when a game is not able to connect to Tournamaxx and there is some question about the information in the Dial-Up Network Screen being correct. After performing a memory clear, Tournamaxx setup information must be re-entered, and an Update From Server should be performed.</p> <p>NOTE: Tournamaxx games must perform an Update From Server BEFORE performing a memory clear.</p>
4 & 7	Complete memory clear	<ul style="list-style-type: none"> Clears ALL memory on hard drive including the Tournamaxx player database, Tournamaxx settings, advertising screens, bookkeeping, high scores, coin-in, options, etc. It resets the game to the factory defaults. It also marks bad sectors on hard drive. <p>A complete memory clear should only be performed when the game is locking up or resetting and it has passed the checksum test. After performing a memory clear, the player database should be reloaded, Tournamaxx setup information must be re-entered, and an Update From Server should be performed.</p> <p>NOTE: Tournamaxx games must perform an Update From Server BEFORE performing a complete memory clear.</p>
3	Watchdog Timer (EVO, Elite Edge, EVO Walette & Fusion games)	<ul style="list-style-type: none"> When the watchdog timer is enabled, it will reboot the machine within 2 minutes of a failure, allowing the game to automatically reset itself if a problem arises.

CONNECTING A PRINTER (GERMAN GAMES ONLY)

To connect a printer to the game as needed:

1. Locate the printer port in the back of the game (see Figure 25).
2. When the game enters idle mode, connect the printer to the printer port on the game.

NOTE: Some printers may cause the game to reboot. Once the game has rebooted and entered idle mode, the printer will begin printing. Do not disconnect the printer until it is finished printing.

Um einen Drucker an eine Maschine anzuschliessen:

1. Den Druckeranschluss hinten am Gerät feststellen (Siehe Fig. 25).
2. Wenn das Geraet in den Leerlauf uebergeht, den Drucker am Druckeranschluss des Geraets anschliessen.

BEMERKUNG: Bei bestimmten Druckern rebootet das Geraet. Nachdem das Geraet dann in den Leerlauf uebergeht, beginnt der Druckvorgang. Den Drucker bitte nicht abschalten bevor der Druckvorgang beendet ist.

Merit Industries, Inc.
Troubleshooting Guide for *Megatouch FORCE™ Games*

PROBLEM	CORRECTIVE ACTION
<ul style="list-style-type: none"> • no power • bill acceptor motor does not run • no flash on the monitor screen • no cooling fans operating • no output from power supply 	<ul style="list-style-type: none"> • Check that the power cord is connected to a "live" outlet. • Check that the power switch is on. • Check that the power cord is connected to the game power supply. • Check that the power supply's voltage select switch is set to the proper voltage. • Check the harness connections to the on/off switch and circuit breaker. • Check the circuit breaker for an "open". • Check the A/C harness connection to the power supply. • Check the line cord.
<ul style="list-style-type: none"> • no video • no cooling fan operation • screen is blank • A/C power to the monitor and bill acceptor • no output from power supply 	<ul style="list-style-type: none"> • Check the power on jumper wire located on the motherboard. It should connect J2 to pin 21 of Panel 1. If this jumper wire is missing or not connected between the correct pins, it may prevent the power supply from turning on. For more information, see Tech Note 52. • Check the D/C harness connection to the motherboard. • Check the A/C harness connection to the power supply.
<ul style="list-style-type: none"> • no video • cooling fans are working • there is a sound when coins are deposited 	<p>Radion, Classic and Upright games:</p> <ul style="list-style-type: none"> • Check the video cable connections to the motherboard and the monitor. • Check the AC power harness to the monitor. • Radion and FORCE Upright monitors will display a test pattern on the screen when the video cable is disconnected from the motherboard and the monitor has power. Disconnect the video cable and if there is no test pattern; replace the monitor chassis board. <p>Walette, Elite Edge, EVO, Fusion, Elite and Vibe:</p> <ul style="list-style-type: none"> • Check the video cable connections to the motherboard and the LCD display (and the monitor control board in EVO and Fusion games). • Check the +12 volt supply voltage to the LCD display (yellow wire +12, black wire ground) • Check the harness connections between the PC boards on the back of the LCD display. • Replace the LCD display.
<ul style="list-style-type: none"> • no video • constant beeping or a sequence of beeps 	<ul style="list-style-type: none"> • The memory card (DIMM) may not be seated properly. Reseat the DIMM or replace it.
<ul style="list-style-type: none"> • no video • no sound when coins are deposited 	<ul style="list-style-type: none"> • Check all connections to the motherboard. • Reseat the DIMM. • Replace the motherboard or send it for repair.
<ul style="list-style-type: none"> • poor picture quality 	<ul style="list-style-type: none"> • Adjust Brightness, Contrast, Horizontal, and Vertical controls with monitor controls.
<ul style="list-style-type: none"> • coin jam 	<ul style="list-style-type: none"> • Check the coin mech and coin chute for coins blocking the pathway. • Make sure the coin harness is connected between the normally open and common terminals on the coin switch. • Disconnect the bill acceptor and the coin switch one at a time to narrow down the problem. • Check the coin harness for pinched or damaged wires. • Disconnect the coin harness from J1, J3, J7, and J8 of the I/O board. If the coin jam still appears, the I/O board will have to be sent for repair. <p><i>(NOTE: The Radion cabinets have an optical coin switch.)</i></p>

Merit Industries, Inc.

Troubleshooting Guide for *Megatouch FORCE™ Games continued*

PROBLEM	CORRECTIVE ACTION
<ul style="list-style-type: none"> meter not advancing 	<ul style="list-style-type: none"> Check connection at I/O board. Check wiring at J2 METER connector on I/O board.
<ul style="list-style-type: none"> game locks up or resets while being played or in the attract mode no movement on the screen power has to be cycled off and on to get the game to function again 	<ul style="list-style-type: none"> Check the output voltages from the power supply: Enhance SFX 1211J Red wire +5 volt Yellow wire +12 volt Blue wire -12 volt White wire +5 volt power good Violet wire +5 volt VSB Black wire ground Brown wire +3.3 volt Clean the vents and the fans of any dust and dirt that may interfere with airflow. Clean the CPU cooling fan on the motherboard. Replace the CPU cooling fan if it is not operating properly. Reseat the DIMM on the motherboard. Clear memory with the following procedure: <ul style="list-style-type: none"> Turn off the game. Press and hold the Setup and Calibrate buttons. Turn the game on and keep holding the buttons until the screen displays "TWO BUTTON CLEAR DETECTED RELEASE BUTTONS". This should take about 30 seconds. Release the buttons. This will clear high scores, clear the books and reset options, and reset the game menu and coin menu to their factory settings. Perform a checksum test on the hard drive: <ul style="list-style-type: none"> Turn off the game. Turn on DIP switch 8 on the I/O board. Turn on the game. The test will take about 10 minutes. <ul style="list-style-type: none"> A failure will cause the test to stop. A passed test will display "DRIVE CHECKSUM COMPLETE RESET ALL DIP SWITCHES TO REBOOT MACHINE". With power on, turn off DIP switch 8.
<ul style="list-style-type: none"> game locks up with "invalid key for version PG3002 – V XXXX" 	<ul style="list-style-type: none"> Check the program number on the security key. It should be compatible with the program on the hard drive. Check the contacts on the security key socket. Lift up on the contact on the bottom of the socket and make sure there is a good connection to the base of the security key. Check the USB cable that connects the I/O board to the motherboard. Try another security key with the same program number or test the security key in another game with the same program version.
<ul style="list-style-type: none"> "INVALID KEY" message while downloading software to the hard drive 	<ul style="list-style-type: none"> If the security key was replaced before the download: <ul style="list-style-type: none"> The motherboard did not boot from the CD-ROM drive. Check that the CD-ROM drive is set as master. Check the ribbon cable connections between the CD-ROM drive and the motherboard. Try another CD-ROM drive or another set of CDs.

Merit Industries, Inc.
 Troubleshooting Guide for *Megatouch FORCE™ Games continued*

PROBLEM	CORRECTIVE ACTION
<ul style="list-style-type: none"> the screen displays MAXX and not FORCE, and the H2H category is missing 	<p>When the game is turned on, it will check the type of touchscreen controller, motherboard and hard drive. If one of these does not match with FORCE hardware, the game will power up and display "MAXX" on the screen and it will not have the H2H category.</p> <ul style="list-style-type: none"> Make sure the game is only using FORCE hardware.
<ul style="list-style-type: none"> game will not download CD 	<ul style="list-style-type: none"> Make sure the CD is installed correctly, with the logo facing up. Check for scratches or a defective CD. Try a different CD-ROM drive or another set of CDs. If you're downloading a CD set, make sure each CD is of the same revision.
<ul style="list-style-type: none"> "ERROR READING DRIVE C" 	<ul style="list-style-type: none"> This message can be caused by the hard drive or in some program versions, a coin jam while the game is turned on. <ol style="list-style-type: none"> Turn the game off. Locate DS 1, position 8 and turn it on. Turn on power to the cabinet. This will start the hard drive checksum test, which should take about 20 minutes to complete. When the hard drive passes the test it will display a "CHECKSUM GOOD" message and continue to boot up into the game attract screens. This indicates a coin jam. When the hard drive fails the test, the game will lock up with a "CHECKSUM ERROR" message, which will stay on the screen until the power is turned off. In this case, the hard drive will have to be replaced.
<ul style="list-style-type: none"> "DISK BOOT FAILURE" 	<p>This message indicates the motherboard is not receiving data from the hard drive and has locked up.</p> <ul style="list-style-type: none"> Check the IDE ribbon cable connections to the motherboard and hard drive. Check the power to the hard drive. It should have +5 volts, +12 volts, and ground.
<ul style="list-style-type: none"> "QUANTUM FIREBALL, SMART FAILURE DETECTED, BACK UP HARD DRIVE" 	<p>The self-diagnostics on the hard drive has detected an error.</p> <ul style="list-style-type: none"> The hard drive will have to be replaced.
<ul style="list-style-type: none"> "CRITICAL ERROR ABORT RETRY FAIL" or "BAD COMMAND OR FILE NAME" error 	<ul style="list-style-type: none"> Try reloading the program onto the hard drive with a different set of update CD's compatible with the security key. If it will not accept the download, try another CD-ROM drive. If it still does not work, replace the hard drive.

Elite Edge Diagrams

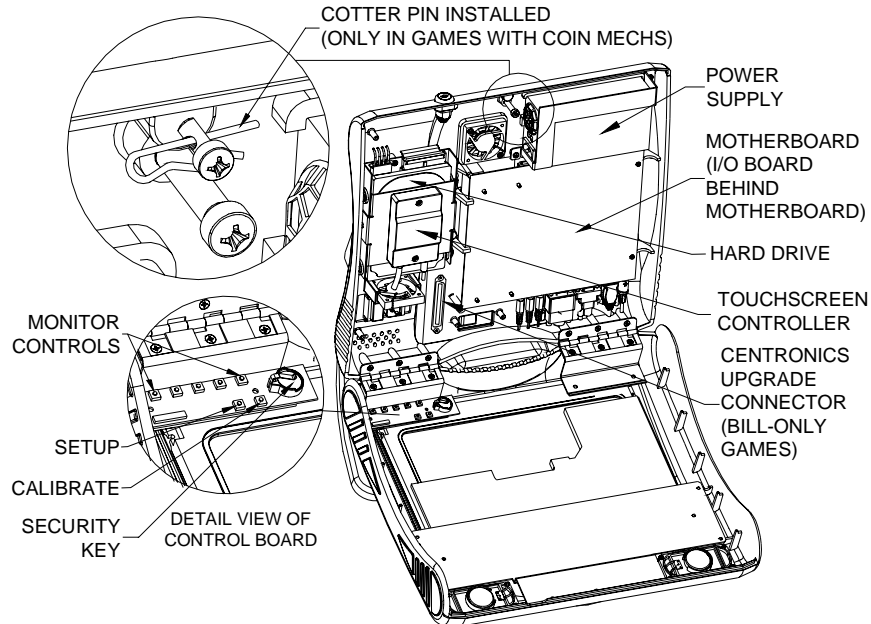

FIGURE 24 - THE ELITE EDGE WITH CPU SECTION OPEN

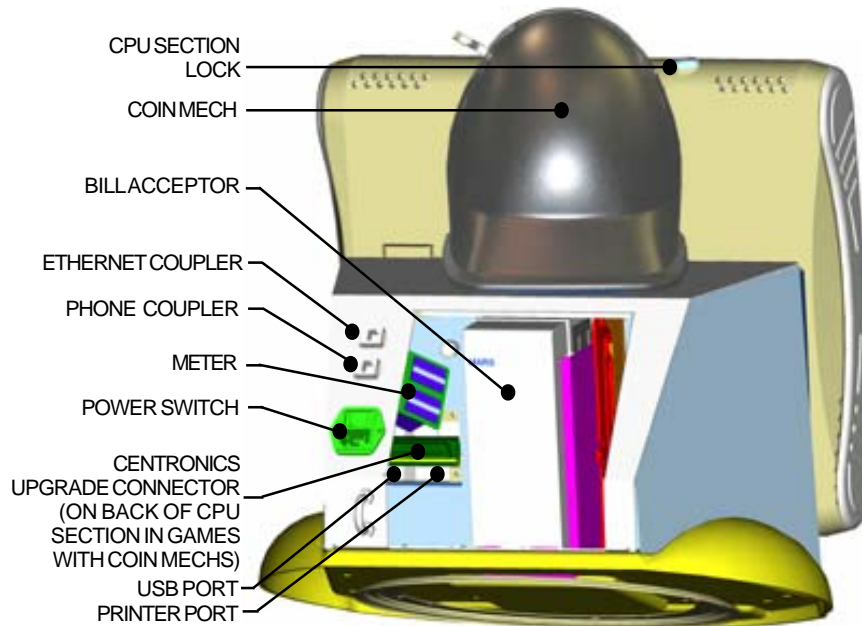

FIGURE 25 - REAR VIEW OF THE ELITE EDGE WITH REAR DOOR OPEN

Megatouch Elite Edge™ Replacement Parts List

REPLACEMENT COMPONENTS ELITE EDGE (G20-108-00X-XX)	
PART NUMBER	DESCRIPTION
SA10057-07	FORCE MOTHERBOARD
EC9796-06	MARS BILL ACCEPTOR. \$1/2/5, 700 STACKER
HW8337-01	MECHANICAL COIN MECH
EC7536-01	POWER SUPPLY, 125W ±12, ±5, +3.3
EC9850-04	TOUCHSCREEN OVERLAY
EC9388-01	15" INTEGRATED LCD
EC9840-08	TOUCHSCREEN CONTROLLER
SA10065-01	I/O BOARD
SA10066-01	CONTROL BOARD
SA3501-XX	FORCE 2006 KEY
PA3024-01	FORCE 2006 PROGRAM ASSEMBLY

NOTE: The parts in your game may vary. When calling for replacement parts, make sure to have your serial number available to ensure the accuracy of your order.

NOTE: In order for your Megatouch FORCE game to function properly, the hardware must only be replaced with FORCE hardware. Replacing the motherboard, I/O board, hard drive or touchscreen controller with hardware that is not specific for FORCE will eliminate some of the FORCE software features.

For additional assistance, after contacting your distributor, contact:

Merit Product Support and Services

USA and Canada call toll-free:

1-800-445-9353

Outside the USA and Canada call:

(215) 639-4700

FAX: (215) 639-5346

Merit Industries, Inc. P.O. Box 5004, Bensalem, PA 19020-8529.

You can also visit our Web site
www.meritind.com

Connection Diagrams

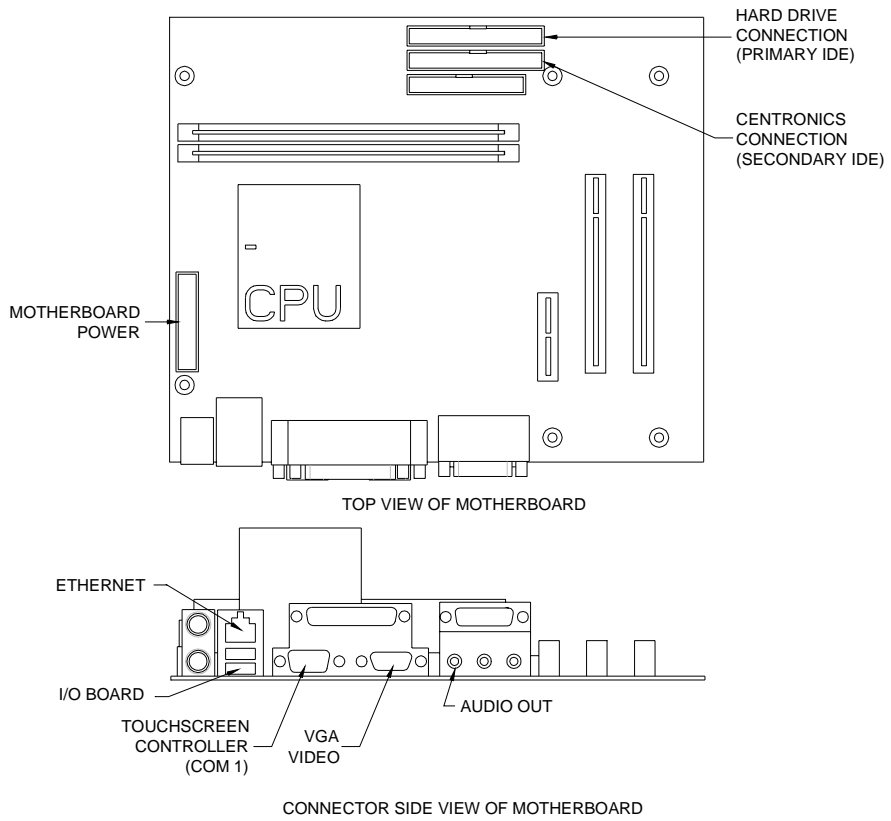

FIGURE 26 - ECS MOTHERBOARD DRAWING

Connection Diagrams

Motherboard - Power Connector

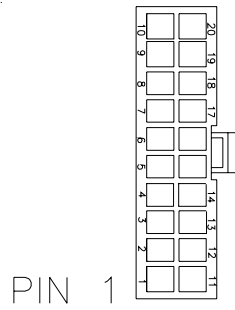

FIGURE 27 - REAR VIEW OF CABLE CONNECTOR

<u>PIN</u>	<u>WIRE COLOR</u>	<u>USE</u>
1	BROWN	+3.3 VDC
2	BROWN	+3.3 VDC
3	BLACK	GND
4	RED	+5 VDC
5	BLACK	GND
6	RED	+5 VDC
7	BLACK	GND
8	WHITE	PWR GOOD
9	VIOLET	+5V VSB
10	YELLOW	+12 VDC
11	BROWN	+3.3 VDC
12	BLUE	-12 VDC
13	BLACK	GND
14	BLACK	GND
15	BLACK	GND
16	BLACK	GND
17	BLACK	GND
18	----	----
19	RED	+5 VDC
20	RED	+5 VDC

Connection Diagrams

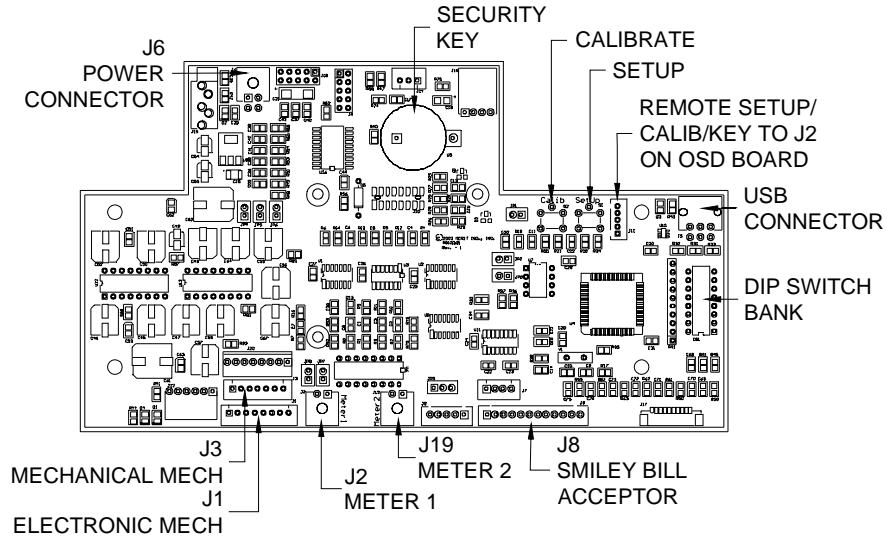

FIGURE 28 - I/O BOARD DRAWING

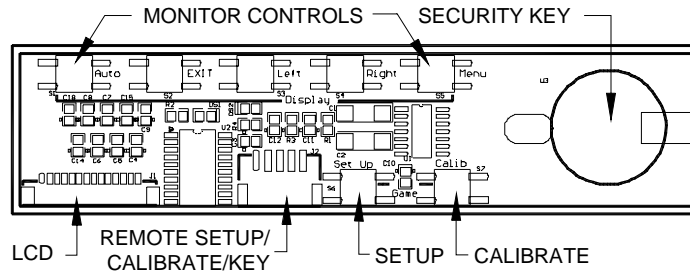

FIGURE 29 - ON-SCREEN DISPLAY BOARD DRAWING

Merit Video Machine Limited Warranty

Merit Industries, Inc. warrants its video machines to be free from defects in material and workmanship for a period of one year from the date of purchase. The warranty covers all electrical components (except fuses and light bulbs) and printed circuit boards. The touchscreen is under warranty for a period of 3 years.

Failure due to misuse, vandalism, excessive or intentional abuse, operation outside specified conditions (including, but not limited to, improper electrical power source), fire, water damage, acts of God, acts of war and civil unrest are specifically excluded.

Merit products are carefully inspected and thoroughly tested prior to packing and shipment. Any damage discovered upon receipt of goods, whether obvious or concealed, must be reported immediately to the delivering carrier and claims made directly to them. Merit assumes no responsibility for damages once the product has left its facilities and any disputes regarding transportation damage must be resolved with the shipping company(s).

Merit will repair or replace, at its option, any component, part or assembly that fails under warranty, provided that the failed item is returned, shipping charges prepaid, to Merit's repair facility and Merit is notified of the failure within the warranty period. Merit reserves the right to request the serial numbers of the item and/or game which has failed, and copies of sales invoices, bills of lading or other documents as required to determine the validity of the warranty coverage. Merit will return or replace warranty items, as specified above, shipping charges prepaid, by ground transportation.

Merit's obligation shall be limited to repair or replacement as stated above, and shall specifically exclude any liability for consequential damages or loss of earnings.

Merit may, at its discretion, provide replacement parts under warranty prior to receiving defective items, without incurring any ongoing obligation to extend such accommodations.

In certain instances, due to geographical or other considerations, Merit may offer PCB warranty service on an extended time basis as follows:

- (a) User notifies Merit in writing (or FAX) of PCB failure, providing dates of failure, serial numbers and a brief description of failure symptoms.
- (b) Failed PCBs are accumulated for a time period or quantity accumulation, as designated by Merit and sent in one shipment to save shipping expenses.
- (c) Merit honors warranty as per dates of failure notification.

The above terms and conditions constitute the sole obligation, written or implied, of Merit Industries under its warranty coverage.

Merit Industries, Inc. Software License Agreement

Merit Industries, Inc. ("Licensor") is willing to license the enclosed software to you only if you accept all of the terms in this license agreement ("Agreement").

Ownership of the Software

1. The enclosed Merit® product, which may include but is not limited to the Megatouch® software program ("Software") and the accompanying written materials are owned by Licensor and are protected by United States copyright laws, patent laws and other intellectual property laws, by laws of other nations, and by international treaties.

Restrictions on Use and Transfer

2. If this Software package contains multiple media types (such as CD's, flash cards, hard drives, etc), then you may use only the type of media appropriate for your Machine. You may not use the other media types on another Machine, or transfer, or assign them to another user except as part of the permanent transfer of the Software and all written materials (as provided for below in paragraph 4).
3. You may make one copy of the software for backup purposes only. You may not copy or make backup copies of any software security key or software security device under any circumstances.
4. You may permanently transfer the right to use the Software and accompanying written materials (including the most recent update and all prior versions) if you retain no copies and the transferee agrees in writing to be bound by the terms of this Agreement. Such a transfer of this license to another party immediately terminates your license. You may not otherwise transfer or assign the right to use the Software, except as stated in this paragraph.
5. You may not operate or allow the operation of the Software at locations where the operation of such Software does not comply with all local, state, and other governmental body laws and regulations. You agree to not use or permit the use of the Software in violation of any U.S. Federal, state, or local laws or regulations or any foreign law or regulation, including laws regarding gaming, gambling or intellectual property rights in or concerning the Software.
6. You may not modify, adapt, translate, reverse engineer, decompile, disassemble the Software or create derivative works from the Software or any component thereof; nor may you remove, modify or hide or otherwise make unreadable or non-viewable any notice, legend, advice, watermark or other designation contained on the Software, component thereof, or output therefrom.
7. You agree that the Software and the authorship, systems, ideas, inventions methods of operation, documentation and other information contained therein, and all versions, modifications and adaptations thereto are proprietary intellectual properties of Licensor and are protected by civil and criminal law, and by copyright, trade secret, trademark and the patent laws of the United States and other countries.

Limited Warranty

8. Licensor warrants, solely for your benefit, that the Software will function in material conformity, with its accompanying documentation for a period outlined in Licensor's standard product warranty period after your receipt of the Software.

Licensor's Obligations Under Warranty

9. Licensor's sole obligation under the aforesaid warranty shall be to utilize commercially reasonable efforts to correct or modify such portion of the Software as to make it materially conform with the applicable documentation.

Grant Of License

10. Licensor grants to you a limited, non-exclusive license to distribute and/or use one copy of the Software on a single Merit ("Machine") accompanied by a single licensor factory authorized security key. Licensor reserves the right to update versions of the software and the content to the Machine as deemed appropriate by the Licensor. You are entrusted to maintain and protect your single licensor factory authorized security key, password, or other identification from being utilized by any third party, and you agree to be responsible for any use of the Software provided herein by a third party utilizing your identification. Licensor maintains the right to immediately terminate your License for reasons related to misuse or other non-conformity with the rules expressed herein. While Licensor does not routinely inspect Machines, Licensor also reserves the right to inspect or audit the Software from time to time in Licensor's sole discretion. To the extent that Licensor's access to the Software requires that Licensor also gain access to a Machine in which the Software is installed, you agree to promptly provide Licensor, when requested, with permission and aid in Licensor gaining access to the Machine.

Disclaimers

11. EXCEPT AS PROVIDED IN THE SECTION ENTITLED "LIMITED WARRANTY", LICENSOR MAKES NO OTHER PROMISES, REPRESENTATIONS OR WARRANTIES, WHETHER EXPRESSED OR IMPLIED, REGARDING OR RELATING TO THE SOFTWARE OR CONTENT THEREIN OR TO ANY OTHER MATERIAL FURNISHED OR PROVIDED TO YOU PURSUANT TO THIS AGREEMENT OR OTHERWISE AND LICENSOR SPECIFICALLY DISCLAIMS ALL IMPLIED WARRANTIES OF MERCHANTABILITY AND FITNESS FOR A PARTICULAR PURPOSE WITH RESPECT TO SAID MATERIALS OR THE USE THEREOF. TO THE MAXIMUM EXTENT ALLOWABLE BY LAW THE UNIFORM COMMERCIAL CODE OR OTHER UNIFORM LAWS SHALL NOT APPLY TO THIS AGREEMENT.

Limitation on Liability

12. IN NO EVENT SHALL LICENSOR BE LIABLE UNDER ANY CLAIM, DEMAND OR ACTION ARISING OUT OF OR RELATING TO THE SOFTWARE, ITS USE, INSTALLATION OR LICENSOR'S PERFORMANCE OR LACK THEREOF UNDER THIS AGREEMENT FOR ANY SPECIAL, INDIRECT, INCIDENTAL, EXEMPLARY OR CONSEQUENTIAL DAMAGES, WHETHER OR NOT LICENSOR HAS BEEN ADVISED OF THE POSSIBILITY OF SUCH CLAIM, DEMAND OR ACTION. IN ADDITION, WITHOUT LIMITING THE FOREGOING, IN ALL EVENTS THE REMEDIES AVAILABLE TO YOU SHALL BE LIMITED TO THE AMOUNT PAID BY YOU TO LICENSOR FOR THE SOFTWARE.
13. IN NO EVENT WILL LICENSOR BE LIABLE TO YOU FOR DAMAGES, INCLUDING ANY LOSS OF PROFITS, LOST SAVINGS, OR OTHER INCIDENTAL OR CONSEQUENTIAL DAMAGES ARISING OUT OF YOUR USE, MISUSE, BREACH OF THIS AGREEMENT OR INABILITY TO USE THE SOFTWARE.

General

14. The validity and construction of this Agreement and of the rights and obligations herein shall be determined and governed by the laws of the State of New York. By accepting the terms of this Agreement, you acknowledge and accept that the courts of New York, New York shall have exclusive jurisdiction and venue regarding any disputes arising with regard to this Agreement or arising out of activity or misuse of the Software.
15. Merit, in its sole discretion, may assign this agreement or any of its rights and obligations hereunder.
16. If you have any questions concerning this Agreement or wish to contact Licensor for any reason, please write: Merit Industries, Inc., 2525 State Road, Bensalem, PA 19020, USA.

Contrat de licence de logiciel de Merit Industries, Inc.

Merit Industries, Inc. (ci-après le "Concédant") est disposé à vous accorder la licence d'utilisation du logiciel ci-inclus, à condition que vous vous engagiez à respecter tous les termes, clauses et conditions du présent contrat de licence (Contrat).

Droit de Propriété

1. Le produit Merit ci-joint contenant, mais ne s'y limitant pas, le logiciel Megatouch™ (ci-après le "logiciel") et toute la documentation écrite, restent la propriété du Concédant et sont protégés par : les lois de droits d'auteur des Etats-Unis, les lois s'appliquant aux brevets déposés et à la propriété intellectuelle, ainsi que par celles des autres pays et les traités internationaux.

Restriction d'Utilisation et Transfert

2. Si le présent logiciel comprend plusieurs types de composants (tels que CD-ROM, cartes flash, disques durs, etc), vous ne pouvez utiliser que ceux qui conviennent à votre appareil. Il est strictement interdit de les utiliser sur un autre appareil, les transférer -ou les céder à un autre utilisateur, sauf en cas de transfert permanent du logiciel et de toute la documentation écrite (comme indiqué ci-dessous au paragraphe 4).
3. Il est interdit de copier le logiciel, à l'exception d'une copie de sauvegarde. Il est aussi interdit de reproduire -ou faire des copies de sauvegarde des programmes de clé de sécurité ou autres fichiers de sécurité, quelles que soient les circonstances.
4. Vous pouvez céder en permanence à un tiers -le droit d'utiliser le LOGICIEL et toute la documentation écrite l'accompagnant, (ainsi que la plus récente mise à jour et toutes autres anciennes versions) seulement si vous n'en gardez aucune copie, et si le cessionnaire s'engage, par écrit, à respecter les termes, clauses et conditions du présent Contrat. Cette cession à un tiers met fin à votre licence immédiatement. Autrement, vous n'avez pas la permission de transférer ou d'accorder à un tiers le droit d'utiliser le présent logiciel, excepté que tel que décrit dans le présent paragraphe.
5. Il est interdit d'utiliser le présent logiciel ou de permettre son utilisation dans des emplacements où l'utilisation du présent logiciel n'est pas conforme aux lois et réglementations locales, nationales ou réglementations d'autres organismes gouvernementaux. Vous acceptez de ne pas utiliser ou d'autoriser l'utilisation du logiciel d'une manière enfreignant les lois ou réglementations s'appliquant à la propriété intellectuelle et au jeu, en vigueur aux Etats-Unis ou dans les autres pays du monde, y compris les lois de l'ensemble du logiciel.
6. Il est interdit de modifier, adapter, traduire, démonter, décompiler, désassembler le logiciel ou créer du matériel dérivé du logiciel ou de tout composant de celui-ci ; vous ne pouvez pas enlever, modifier ou cacher ou rendre illisible ou non-visible toute instruction, légende, information ou filigrane ou autre désignation qui apparaît dans le logiciel, composant dudit logiciel ou résultant dudit logiciel.
7. Vous convenez que le logiciel et les droits d'auteur, les systèmes, les idées, les inventions, les méthodes d'utilisation, la documentation et autre information incluse, ainsi que toutes les versions, modifications et adaptations qui s'y rattachent sont les propriétés intellectuelles du Concédant et sont protégées par le droit civil et pénal et par le droit d'auteur, le secret commercial, la marque déposée et le brevet aux Etats-Unis et dans les autres pays du monde.

Limite de Garantie

8. Le Concédant garantit seulement à votre intention, que le logiciel permettra une utilisation conforme, avec la documentation l'accompagnant, pendant la période de temps indiquée dans la période de garantie du produit standard du Concédant, à compter de la date de livraison du logiciel.

Responsabilité du Concédant aux termes de la Garantie

9. La seule obligation du Concédant aux termes de la garantie susmentionnée sera de faire tous les efforts commercialement raisonnables pour corriger ou modifier la partie du logiciel pour le rendre matériellement conforme aux spécifications de la documentation.

Concession de Licence

10. Le Concédant vous accorde le droit d'utiliser une seule copie par appareil Merit (ci-après "Appareil") accompagné d'une seule clé de sécurité autorisée en usine et fournie par le Concédant. Le Concédant se réserve le droit de mise à jour des versions du logiciel et du contenu de l'Appareil, quand il juge nécessaire de le faire. Il vous appartient également d'empêcher que les mots de passe ou autres codes et la clé de sécurité soient utilisés par un tiers. Vous acceptez d'assumer la responsabilité dans le cas de l'utilisation du logiciel par un tiers. Le Concédant se réserve le droit de résilier votre contrat de licence à tout moment dans l'éventualité d'une utilisation non-conforme aux clauses stipulées. Bien que le Concédant ne contrôle pas les appareils périodiquement, il se réserve toutefois le droit de contrôler le logiciel à tout moment et sans préavis de sa part. De surcroît, dans l'éventualité où le logiciel n'est accessible qu'à travers la machine dans laquelle il est installé, le licencié s'engage à donner libre accès au Concédant, ou ses représentants, à la machine et dans les plus brefs délais.

Exclusion de toute autre garantie

11. EXCEPTÉ COMME PRÉVU DANS LA SECTION INTITULÉE "LIMITE DE GARANTIE", LE CONCEDANT N'ASSURE AUCUNE AUTRE GARANTIE DE QUELQUE NATURE ET À QUELQUE TITRE QUE CE SOIT, EXPLICITE OU IMPLICITE, EN RAPPORT AVEC LE LOGICIEL ET LES COMPOSANTS QUI L'ACCOMPAGNENT OU, LE CAS ÉCHÉANT, TOUT SUPPORT OU MATÉRIEL FOURNI CONFORMEMENT AU PRÉSENT CONTRAT EN PARTICULIER, LE CONCEDANT NE PEUT DONNER AUCUNE GARANTIE, DE QUELQUE NATURE QUE CE SOIT, POUR LA COMMERCIALISATION DE TOUS LES PRODUITS EN RAPPORT AVEC LE LOGICIEL OU AVEC L'UTILISATION DE CELUI-CI. DANS LA MESURE OU CELA EST PERMIS PAR LA LOI, LE CODE UNIFORME COMMERCIAL OU AUTRE LOI UNIFORME NE S'APPLIQUE PAS AU PRÉSENT CONTRAT.

Limite de Responsabilité

12. LE CONCEDANT NE SERA EN AUCUN CAS RESPONSABLE DE TOUTE RECLAMATION, DEMANDE OU ACTION RESULTANT DE OU EN RAPPORT AVEC LE LOGICIEL, SON UTILISATION OU SON INSTALLATION, OU LA PERFORMANCE OU MANQUE DE PERFORMANCE DU CONCEDANT EN VERTU DU PRÉSENT CONTRAT POUR TOUS DOMMAGES D'UNE NATURE QUI N'EST PAS PRÉSUMÉE PAR LA LOI ET QUI DOIVENT ÊTRE EXPRESSEMENT Prouvés, DOMMAGE INDIRECTS, DOMMAGES-INTERETS POUR PRÉJUDICE MORAL, QUE LE CONCEDANT AIT ÉTÉ AVISÉ OU NON DE LA POSSIBILITÉ D'UNE TELLE RECLAMATION, DEMANDE OU ACTION. DE PLUS, SANS LIMITER CE QUI PRÉCÈDE, LES DÉDOMMAGEMENTS À VOTRE DISPOSITION SERONT LIMITÉS AU MONTANT QUE VOUS AUREZ PAYÉ AU CONCEDANT POUR LE LOGICIEL.
13. LE CONCEDANT NE SERA EN AUCUN CAS RESPONSABLE : D'UNE RUPTURE DE CONTRAT, DES DOMMAGES, Y COMPRIS TOUTE PERTE DE PROFIT, PERTES D'ÉCONOMIE OU TOUS AUTRES DOMMAGES INDIRECTS OU DOMMAGES-INTERETS ACCESSOIRES DECOULANT DE LA MAUVAISE UTILISATION OU DE L'IMPOSSIBILITÉ D'UTILISATION DU LOGICIEL.

Dispositions Générales

14. La validité et la construction du présent Contrat et les droits et obligations ci-inclus seront déterminés et régis par les lois de l'état de New York aux États-Unis. En acceptant les dispositions du présent contrat, vous acceptez également que tous litiges ou revendications relatives seront réglés par voie d'arbitrage par un tribunal de l'état de New York, aux États-Unis.
15. Merit Industries se réserve le droit de transférer le présent Contrat à un tiers ainsi que ses droits et obligations ci-après.
16. Pour toutes questions concernant le présent Contrat -ou si vous désirez contacter le Concédant pour une raison quelconque, veuillez écrire à : Merit Industries, Inc., 2525 State Road, Bensalem, PA 19020, États-Unis.

Merit Industries, Inc. Softwarelizenzabkommen

Merit Industries, Inc. („Lizenzgeber“) ist nur dann bereit Ihnen eine Lizenz für die beiliegende Software zu erteilen, wenn Sie alle Bestimmungen dieses Lizenzabkommens („Abkommen“) akzeptieren.

Eigentumsvorbehalt der Software

1. Das beiliegende Merit®-Produkt, welches das Megatouch® Softwareprogramm („Software“) beinhalten kann, aber nicht darauf beschränkt ist, und die schriftlichen Unterlagen sind Eigentum des Lizenzgebers und sind durch die Gesetze der Vereinigten Staaten und anderer Länder und durch internationale Verträge urheberrechtlich geschützt.

Beschränkungen im Gebrauch und Transfer

2. Sollte diese Softwarelieferung mehrere Medien enthalten (z.B. CD, Karten, Festplatten usw.), dürfen Sie nur die für Ihre Maschine angebrachte Medienart verwenden. Die anderen Medienarten dürfen nicht auf anderen Maschinen verwendet werden oder an Dritte übergeben werden, abgesehen von einem endgültigen Transfer der Software und aller schriftlichen Unterlagen (wie im untenstehenden Paragraphen 4 beschrieben).
3. Sie dürfen nur eine Sicherungskopie der Software herstellen. Unter keinen Umständen dürfen Sie einen Softwaresicherungsschlüssel oder Sicherungsmaßnahmen kopieren oder davon Sicherungskopien herstellen.
4. Sie dürfen das Nutzungsrecht für die Software und die schriftlichen Unterlagen (einschließlich der aktuellen Version und aller vorhergehenden Versionen) an Dritte übertragen, wenn Sie keine Kopie behalten und wenn der Empfänger die Bestimmungen dieses Abkommens in schriftlicher Form akzeptiert. Bei einem solchen Transfer der Lizenz an Dritte erlischt Ihre Lizenz umgehend. Abgesehen von den Bestimmungen dieses Paragraphen sind alle anderen Transfers oder Übertragungen der Nutzungsrechte für diese Software unerlaubt.
5. Sie dürfen die Software nicht benutzen oder eine Nutzung gestatten, wenn eine solche Nutzung der Software irgendwelche Gesetze und Verordnungen der kommunalen oder staatlichen Behörden verletzen würde. Sie verpflichten sich die Software nicht so zu nutzen oder nutzen zu lassen, dass sie damit gegen staatliche, Bundes- oder Lokalgesetze oder Bestimmungen der USA oder gegen ausländische Gesetze oder Bestimmungen, einschliesslich aller Gesetze bezüglich Glücksspiels, Spielens oder geistigen Eigentumsrechts der Software, verstossen.
6. Es ist Ihnen nicht gestattet, die Software abzuändern, zu verändern, zu übersetzen, rückumzuwandeln, zu dekompileieren oder zu zerlegen, oder aus der Software oder eines Teils davon andere Werke abzuleiten. Sie dürfen auch aus der Software, einem Bestandteil der Software oder aus den Datenausgaben der Software keine Hinweise, Bemerkungen, Ratschläge, Wasserzeichen oder andere Markierungen entfernen, verändern, verbergen oder auf andere Art unlesbar machen.
7. Sie akzeptieren, dass die Software und die Urheberschaft, die Systeme, die Ideen, Erfindungen, die Arbeitsweisen, die Dokumentation und alle anderen darin enthaltenen Informationen und alle Versionen, Veränderungen, und Bearbeitungen davon das geistige Eigentum des Lizenzgebers sind, und dass sie durch Straf- und Zivilgesetzgebung und durch die Copyright-, Geschäftsgeheimnis-, Warenzeichen- und die Patentgesetze der Vereinigten Staaten und anderer Länder geschützt sind.

Beschränkte Garantie

8. Der Lizenzgeber garantiert zu Ihren Gunsten, dass die Software für die angegebene normale Garantiezeit des Lizenzgebers nach Ihrer Annahme der Software in erheblicher Übereinstimmung mit der beiliegenden Dokumentation laufen wird.

Verpflichtung des Lizenzgebers im Rahmen der Garantie

9. Die ausschließliche Pflicht des Lizenzgebers im Rahmen der vorstehenden Garantie besteht darin, alle geschäftlich vertretbaren Schritte zu unternehmen, um Teile der Software zu berichtigen oder abzuändern, bis sie mit der beiliegenden Dokumentation erheblich übereinstimmen.

Übertragung der Lizenz

10. Der Lizenzgeber gewährt Ihnen eine beschränkte, nicht-ausschliessbare Lizenz zur Vertreibung und/oder Benutzung einer Kopie der Software auf einem einzelnen Merit™ („Gerät“) mit einem einzelnen werksmäßig gestatteten Sicherheitsschlüssel. Der Lizenzgeber behält sich das Recht vor, nach eigenem Ermessen die Software und den Inhalt der Maschine zu verbessern. Sie sind dafür verantwortlich ihren individuellen, vom Lizenzgeber werksmäßig gestatteten Sicherheitsschlüssel, ihr Passwort oder anderweitigen Identifikationsmechanismus instandzuhalten und abzusichern gegen die Nutzung durch eine dritte Partei, und sie akzeptieren die Verantwortung für jegliche Nutzung der besagten Software durch eine dritte Partei mithilfe ihres Identifikationsmechanismus. Obwohl der Lizenzgeber nicht regelmässig Maschinen inspiziert, behält sich der Lizenzgeber das Recht vor, ihre Lizenz umgehend zu kündigen aus Gründen des Missbrauchs oder bei Nichtbefolgung der Bestimmungen in diesem Vertrag. Der Lizenzgeber behält sich ebenfalls das Recht vor, die Software von Zeit zu Zeit nach eigenem Ermessen zu inspizieren oder zu überprüfen. Im Falle, dass der Lizenzgeber Zugang zu dem Gerät wünscht, in dem besagte Software installiert ist, erklären Sie sich bereit, dass sie dem Lizenzgeber, wenn nötig, Erlaubnis und Hilfe beim Zugang zum Gerät verschaffen.

Beschränkungen

11. ABGESEHEN VON DEN BESTIMMUNGEN DES PARAGRAPHEN „BESCHRÄNKTE GARANTIE“ GIBT DER LIZENZGEBER KEINE SONSTIGEN VERSPRECHEN, VERPFLICHTUNGEN ODER GARANTIEEN, OB AUSDRÜCKLICH ODER STILLSCHWEIGEND, FÜR DIE SOFTWARE ODER IHRE BESTANDTEILE ODER FÜR ALLE ANDEREN MATERIALIEN, DIE IHNEN IM RAHMEN DIESES ABKOMMENS ZUR VERFÜGUNG GESTELLT ODER ÜBERLASSEN WERDEN, UND DER LIZENZGEBER LEHNT AUSDRÜCKLICH ALLE ANSPRÜCHE AUF MARKTFÄHIGKEIT UND EIGNUNG DER BESAGTEN MATERIALIEN FÜR DEN GEWÖHNLICHEN GEBRAUCH AB. SOWEIT GESETZESMÄSSIG ZUGELASSEN, SOLLEN DIE HANDELSRECHTLICHE GESETZGEBUNG AUS DEM UNIFORM COMMERCIAL CODE ODER ANDERE GESETZE AUF DIESES ABKOMMEN NICHT ANWENDBAR SEIN.

Haftungsbeschränkung

12. DER LIZENZGEBER HAT KEINERLEI HAFTUNG BEI EINEM ANSPRUCH, EINER FORDERUNG ODER EINER KLAGE, DIE AUF NUTZUNG DER SOFTWARE, DEREN INSTALLIERUNG, DER LEISTUNG DES LIZENZGEBERS ODER DESSEN VERSAGEN IM RAHMEN DIESES ABKOMMENS FÜR JEGLICHE FOLGE-, INDIREKTE, SONDER- ODER NEBENSCHÄDEN BERUHEN, SELBST WENN DER LIZENZGEBER AUF DIE MÖGLICHKEIT EINES SOLCHEN ANSPRUCHES, EINER FORDERUNG ODER EINER KLAGE HINGEWIESEN WURDE. WEITERHIN UND OHNE BESCHRÄNKUNG DES LETZTEN SATZES, DÜRFEN IN ALLEN FÄLLEN DIE IHNEN ZUR VERFÜGUNG STEHENDEN ABHILFEN DIE VON IHNEN FÜR DIE SOFTWARE AN DEN LIZENZGEBER GEZAHLTE SUMME NICHT ÜBERSCHREITEN.
13. DER LIZENZGEBER HAT IN KEINEM FALLE EINE HAFTUNG IHNEN GEGENÜBER FÜR SCHÄDEN, EINSCHLIESSLICH ETWAIGER GEWINNVERLUSTE, NICHT REALISierter EINSPARUNGEN ODER ANDERER NEBEN- ODER FOLGESCHÄDEN, DIE AUS IHRER VERWENDUNG, MISSBRAUCH, VERLETZUNG DIESES ABKOMMENS ODER GEBRAUCHSUNFÄHIGKEIT DER SOFTWARE ENTSTEHEN.

Allgemein

14. Die Rechtsgültigkeit und Provisionen dieses Abkommens und der darin enthaltenen Rechte und Pflichten werden durch die Gesetze des Staates von New York bestimmt. Sollten sie diese Vereinbarungen annehmen, dann akzeptieren Sie, dass der ausschliessliche Erfüllungsort und Gerichtsstand bei den Gerichten von New York im Staat New York liegen hinsichtlich aller Streitigkeiten, die diesen Vertrag betreffen, oder die durch Leistung oder Missbrauch der besagten Software entstehen.
15. Merit kann nach eigenem Ermessen dieses Abkommen oder jedes der darin enthaltenen Rechte und Pflichten an Dritte abtreten.
16. Bei Rückfragen über dieses Abkommen oder wenn Sie den Lizenzgeber aus einem anderen Grund kontaktieren wollen, bitte schreiben an: Merit Industries, Inc., 2525 State Road, Bensalem, PA 19020, USA.

Please read the enclosed license agreement. Operation of this game constitutes acceptance of the Merit Software License Agreement.

Veillez lire le contrat de licence d'utilisation ci-inclus. Si vous utilisez ce jeu, vous vous engagez à respecter les termes et conditions du contrat de licence d'utilisation du logiciel de Merit.

Bitte beiliegendes Lizenzabkommen durchlesen. Das Merit Software Lizenzabkommen tritt in Kraft, sobald dieses Spiel verwendet wird.